

# VARIO30

## PŘISAZENÉ PROFILY SURFACE PROFILES



nůžky  
scissors



pila  
hacksaw



lepidlo  
glue



vrtačka  
drill



šroubovák  
screwdriver



nůžky na plech  
metal shears



bavlněné rukavice  
cotton gloves

| profily<br>profiles   | koncovky<br>endings          | pomocné profily<br>assistant profiles  | držáky<br>mountings  |
|---|------------------------------|--|--|
| <p>08 kryt napájecího zdroje VARIO30-08<br/>power supply cover VARIO30-08</p> | <p>08A, 08B<br/>08C, 08D</p> | <p>09 profil VARIO30-09<br/>profile VARIO30-09</p>                                       | <p>Y1 držák Y pružný otvor oválný<br/>Y flexible mounting plate</p>          |
| <p>01 profil VARIO30-01<br/>profile VARIO30-01</p>                            | <p>01</p>                    | <p>10 profil VARIO30-10<br/>profile VARIO30-10</p> <p>profil FIX16<br/>profile FIX16</p> | <p>Y2 držák Y pružný otvor zahloubený<br/>cone Y flexible mounting plate</p> |
| <p>02 profil VARIO30-02<br/>profile VARIO30-02</p>                            | <p>02</p>                    |  | <p>T držák T<br/>T mounting plate</p>  |
| <p>03 profil VARIO30-03<br/>profile VARIO30-03</p>                            | <p>03</p>                    |  |  |

## ZAVĚŠENÉ VARIANTY PENDANT VARIANTS

## PŘISAZENÉ VARIANTY SURFACE VARIANTS

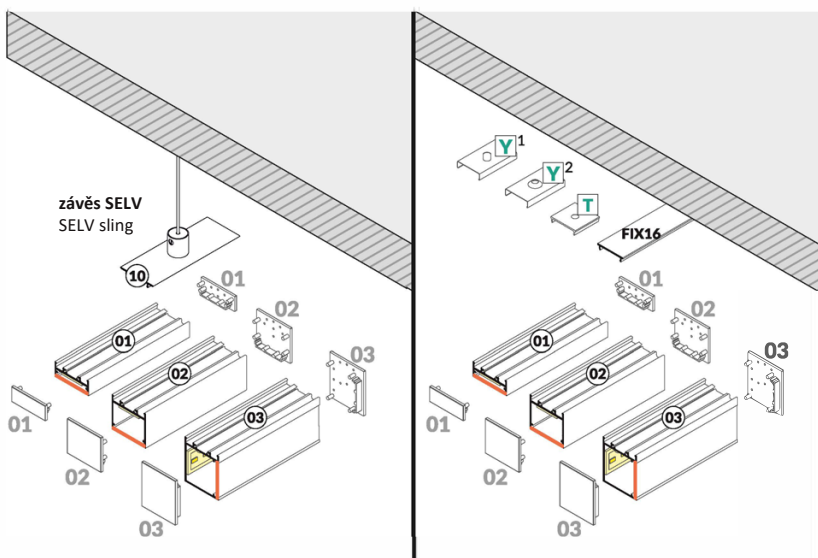

## VARIANTY S KRYTEM NAPÁJECÍHO ZDROJE VARIANTS WITH POWER SUPPLY COVER

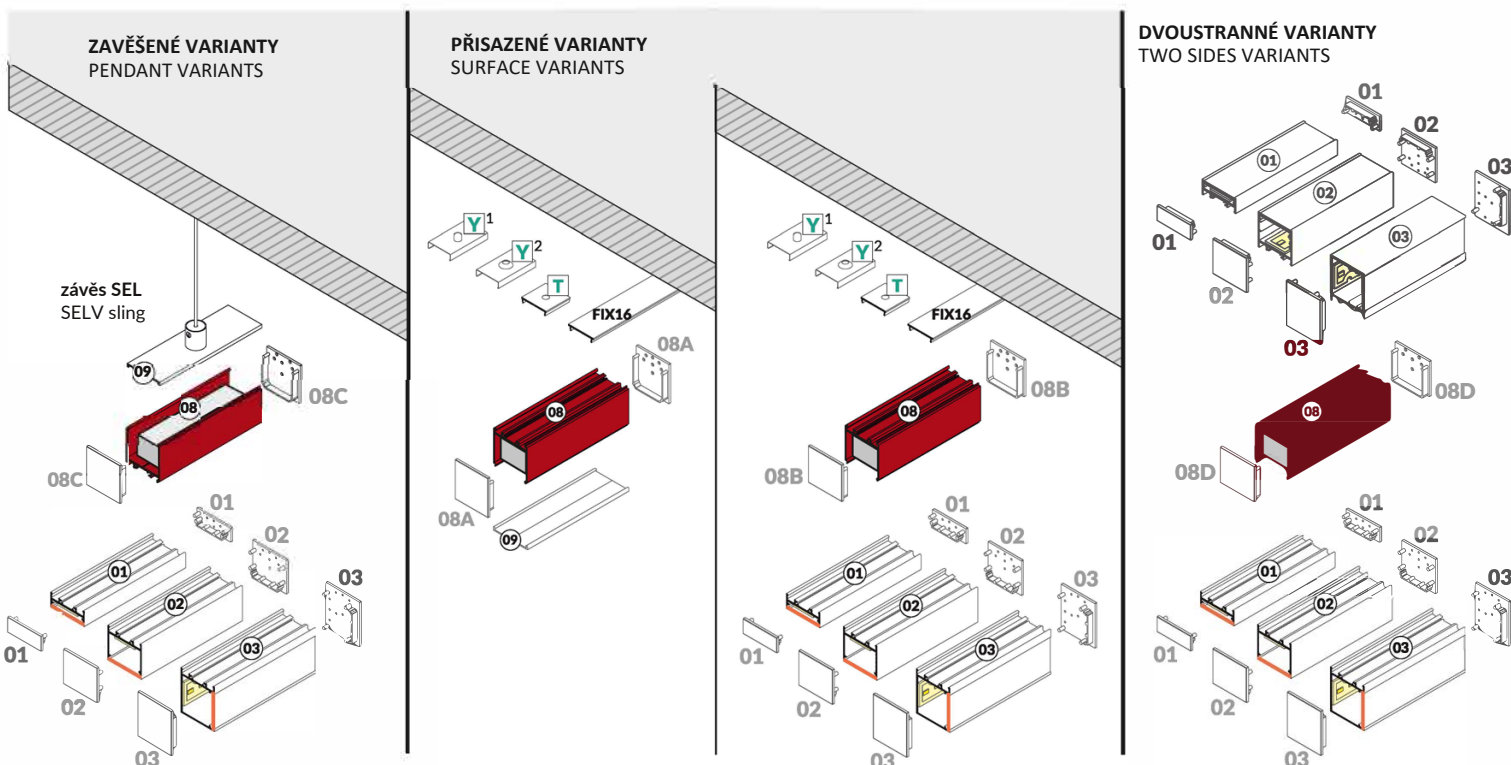

**I**

**VARIO30-01**  
**VARIO30-02**  
**VARIO30-03**  
 difuzor / diffuser  
 A9, C9, D9, E9

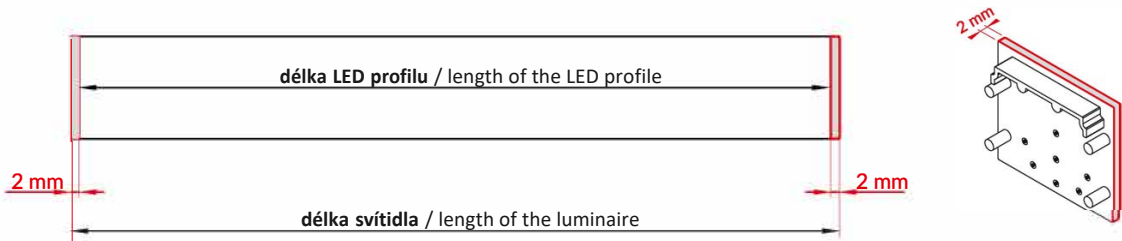
**II**

**VARIO30-01**  
**VARIO30-02**  
**VARIO30-03**  
 difuzor / diffuser  
 A9, C9, D9, E9

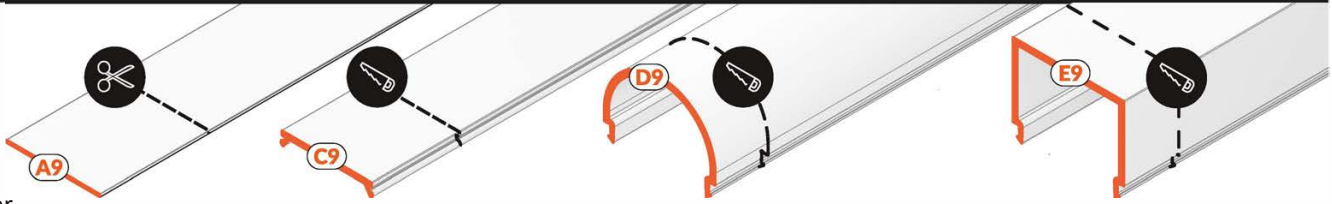

**Pozn.!** Délka difuzoru je stejná jako délka profilu  
**Note!** The length of the cover is equal to the length of the profile

**III**

**VARIO30-01**  
 difuzor / diffuser  
 A9, E9

**DOPORUČENÝ LED PÁSEK**  
**RECOMMENDED LED STRIP**

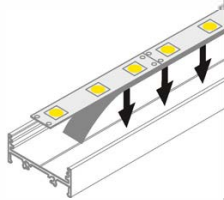
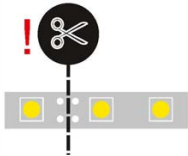

**VARIO30-01**  
 difuzor / diffuser  
 D9, E9

**DOPORUČENÝ LED MODUL**  
**RECOMMENDED LED MODULE**  
**PHILIPS Fortimo LED strip LV**

**Pozn.!** Je možno použít LED pásek o šířce max. 30mm  
**Note!** Possible to use LED strip max 30 mm width

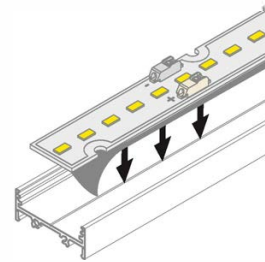

**oboustranná teplovodivá lepicí páska 15 mm x 50 m**  
**double-sided adhesive thermally conductive tape 15 mm x 50 m**

**VARIO30-02**  
**VARIO30-03**  
 difuzor / diffuser  
 A9, C9, D9, E9

**DOPORUČENÝ LED MODUL**  
**RECOMMENDED LED MODULE**  
**PHILIPS Fortimo LED strip LV**

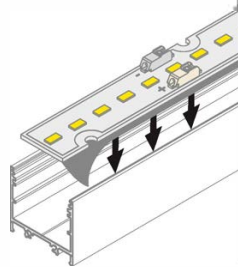

**Pozn.!** Je možno použít LED pásek o šířce max. 30mm  
**Note!** Possible to use LED strip max 30 mm width

**oboustranná teplovodivá lepicí páska 15 mm x 50 m**  
**double-sided adhesive thermally conductive tape 15 mm x 50 m**

## **IV** PŘÍSLUŠENSTVÍ / ACCESSORIES

**držák VARIO30 LED fixátor**  
**VARIO30 LED clamp**

**VARIO30-02**  
 difuzor / diffuser  
 A9, C9, D9, E9

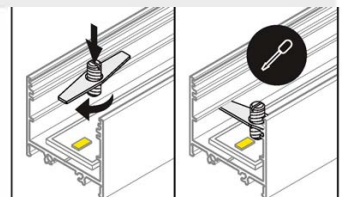
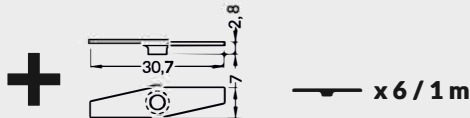

držák VARIO30-1 LED fixátor  
VARIO30-1 LED clamp

**VARIO30-03**  
difuzor / diffuser  
A9, C9, D9, E9



x 6 / 1 m

A9 C9 D9 E9

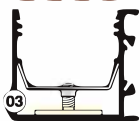

VARIO30-03

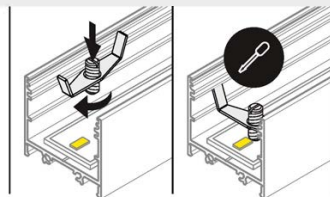

VARIO30 LED montážní podložka  
VARIO30 LED mounting

**VARIO30-02**  
**VARIO30-03**  
difuzor / diffuser  
A9, C9, D9, E9

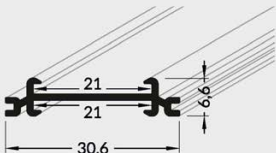

A9 C9 D9 E9

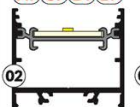

VARIO30-02

D9 E9

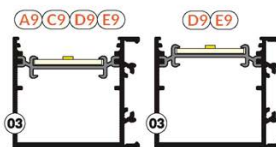

VARIO30-03

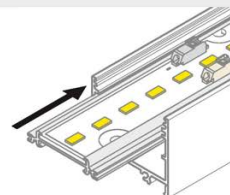
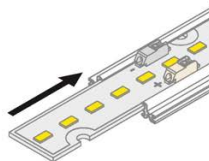
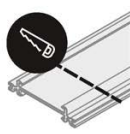

VARIO30 LED montážní podložka  
VARIO30 LED mounting

**VARIO30-02**  
**VARIO30-03**  
difuzor / diffuser  
A9, C9, D9, E9

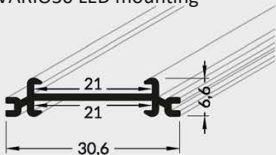

držák VARIO30 LED fixátor  
VARIO30 LED clamp



x 6 / 1 m

A9 C9 D9 E9

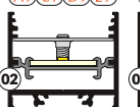

VARIO30-02

A9 C9 D9 E9

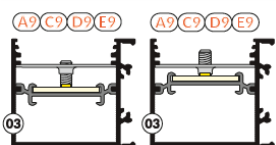

VARIO30-03

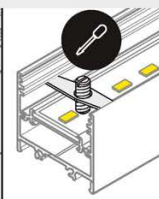
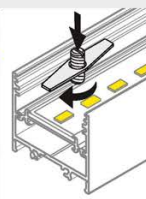
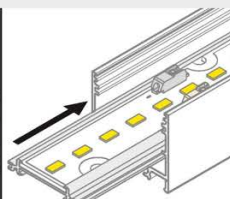
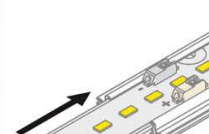
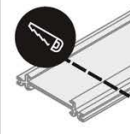

VARIO30 LED montážní podložka  
VARIO30 LED mounting

**VARIO30-02**  
**VARIO30-03**  
difuzor / diffuser  
A9, C9, D9, E9

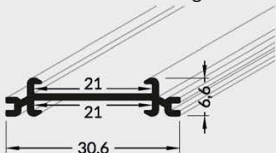

držák VARIO30-1 LED fixátor  
VARIO30-1 LED clamp



x 6 / 1 m

A9 C9 D9 E9

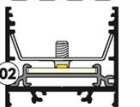

VARIO30-02

A9 C9 D9 E9



VARIO30-03

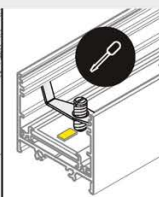
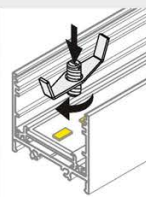
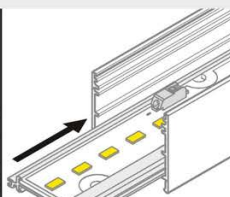
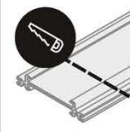

**VARIO30-02**  
**VARIO30-03**  
**difuzor / diffuser**  
**A9, C9, D9, E9**

**VARIO30 LED montážní podložka**  
**VARIO30 LED mounting**

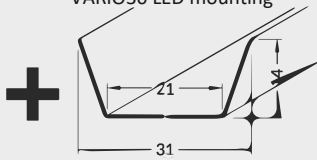

**držák VARIO30-1 LED fixátor**  
**VARIO30-1 LED clamp**

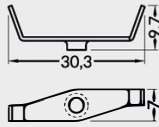

**x 6 / 1 m**



**VARIO30-02**

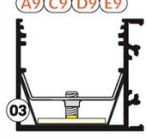

**VARIO30-03**

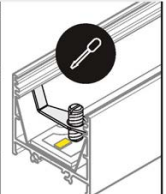
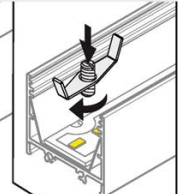
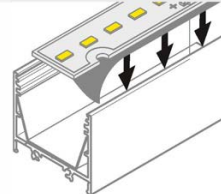
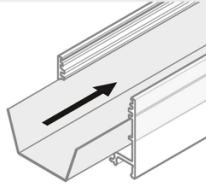
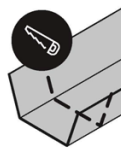

**oboustranná teplovodivá lepicí páska 15 mm x 50 m**  
**double-sided adhesive thermally conductive tape 15 mm x 50 m**

**V**

**VARIO30-01**  
**VARIO30-02**  
**VARIO30-03**  
**difuzor / diffuser**  
**A9, C9, D9, E9**

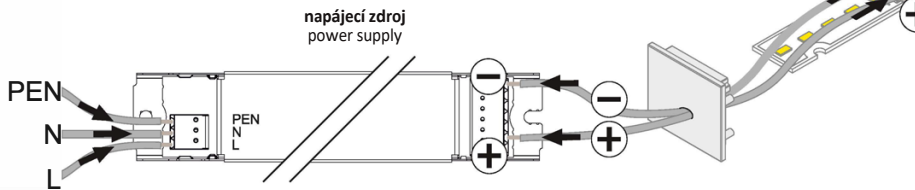

**Pozn.!** Koncovka s označenými místy pro vyvrtání otvorů. Možnost zakoupení speciálních vrutů.  
**Note!** Ending with market space to bore the holes. Possibility of buying dedicated screws.

**VARIO30-01**  
**VARIO30-02**  
**VARIO30-03**  
**difuzor / diffuser**  
**A9**

**difuzor A9 nasouvací**  
**A9 slide cover**

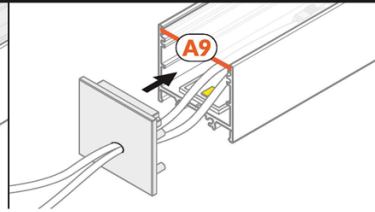
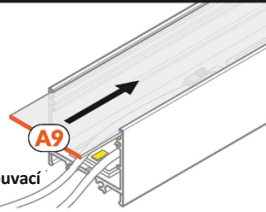

**VARIO30-01**  
**VARIO30-02**  
**VARIO30-03**  
**difuzor / diffuser**  
**C9**

**difuzor C9 klip**  
**C9 click cover**

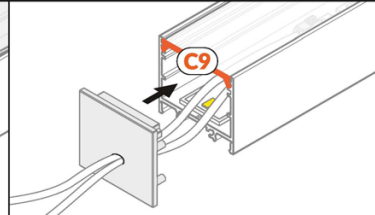
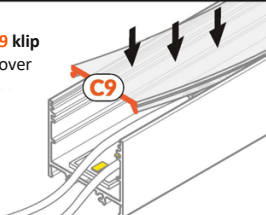

**VARIO30-01**  
**VARIO30-02**  
**VARIO30-03**  
**difuzor / diffuser**  
**E9**  
**koncovka / ending**  
**E9**

**difuzor E9 klip**  
**E9 click cover**

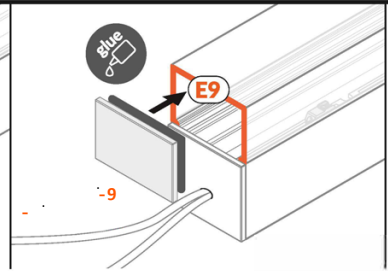
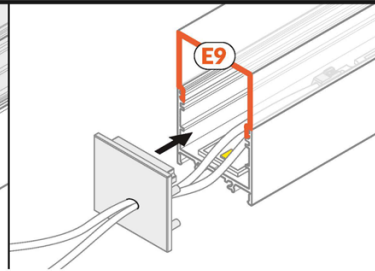
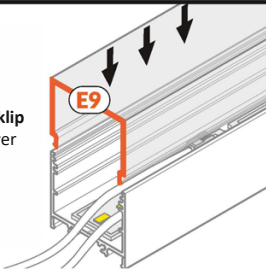

**VARIO30-01**  
**VARIO30-02**  
**VARIO30-03**  
**difuzor / diffuser**  
**D9**  
**koncovka / ending**  
**D9**

**difuzor D9 klip**  
**D9 click cover**

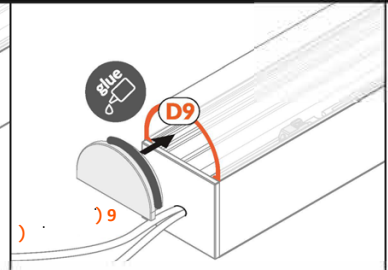
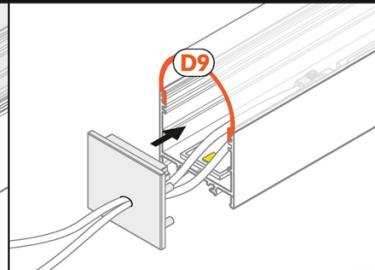
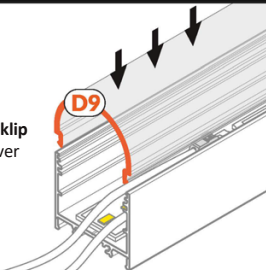

**VII**

**VARIO30-01**  
**VARIO30-02**  
**VARIO30-03**  
**difuzor / diffuser**  
**A9, C9, D9, E9**

**VARIO30-08 kryt zdroje**  
**VARIO30-08 power supply cover**

**VARIO30-01**  
**VARIO30-02**  
**VARIO30-03**

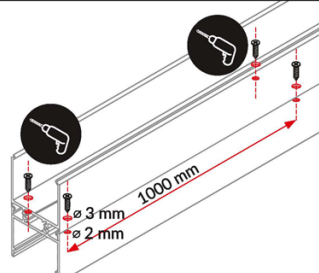
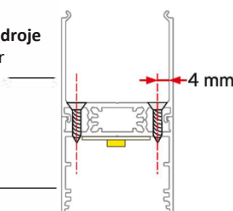

**kabelová průchodka 5mm**  
**wires cover 5mm**

**VARIO30-08 kryt zdroje**  
**VARIO30-08 power supply cover**

**VARIO30-01**  
**VARIO30-02**  
**VARIO30-03**

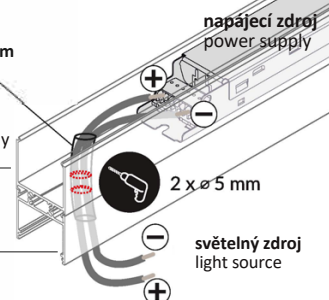

**VARIANTA 16-E9 / VARIANT 16-E9**  
**difuzor / diffuser**  
**E9**

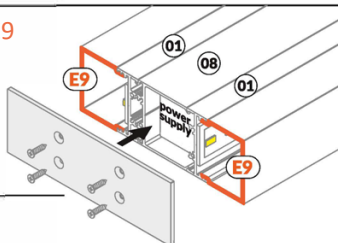
 koncovka VARIO30-16-E9 kovová  
 VARIO30-16-E9 metal ending

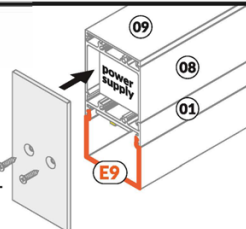
**VARIANTA 19-E9 / VARIANT 19-E9**  
**difuzor / diffuser**  
**E9**

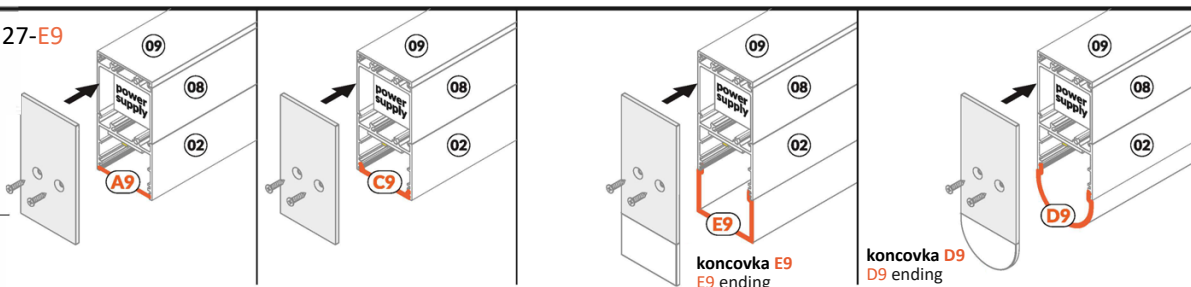
 koncovka VARIO30-19-E9 kovová  
 VARIO30-19-E9 metal ending

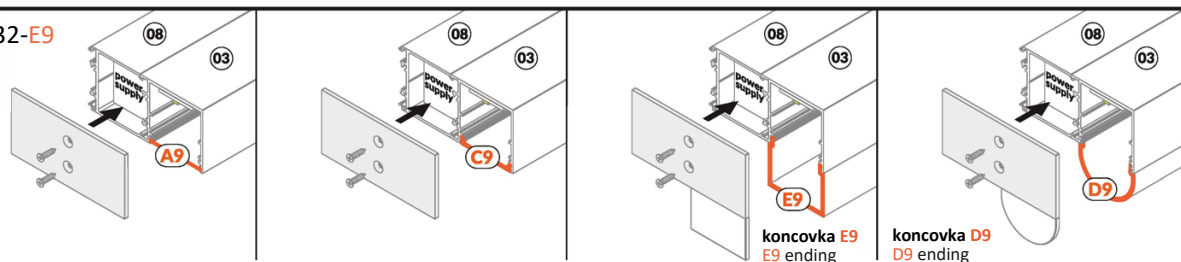
**VARIANTA 27-E9 / VARIANT 27-E9**  
**difuzor / diffuser**  
**A9, C9, E9, D9**

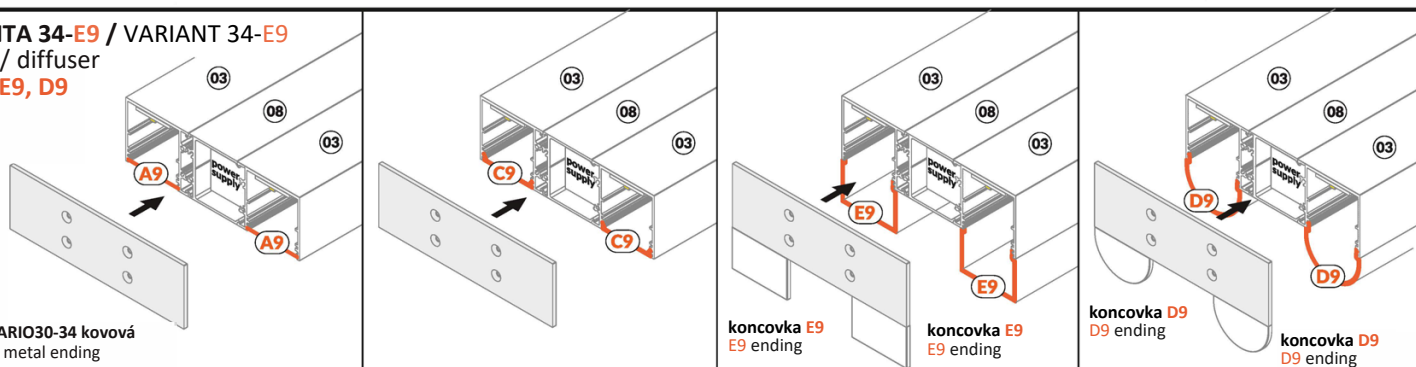
 koncovka VARIO30-27 kovová  
 VARIO30-27 metal ending

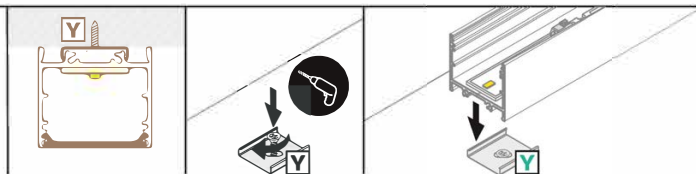
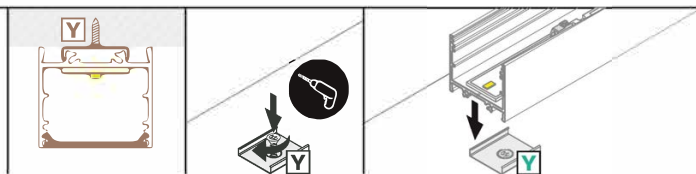
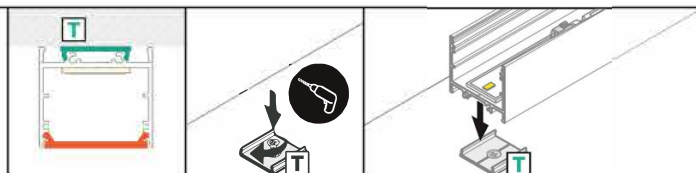
**VARIANTA 32-E9 / VARIANT 32-E9**  
**difuzor / diffuser**  
**A9, C9, E9, D9**

 koncovka VARIO30-32 kovová  
 VARIO30-32 metal ending

**VARIANTA 34-E9 / VARIANT 34-E9**  
**difuzor / diffuser**  
**A9, C9, E9, D9**

 koncovka VARIO30-34 kovová  
 VARIO30-34 metal ending

**VARIO30-01**  
**VARIO30-02**  
**VARIO30-03**  
**difuzor / diffuser**  
**A9, C9, D9, E9**

 držák Y pružný  
 Y flexible mounting plate

 držák Y pružný zahlužený  
 cone Y flexible mounting plate

 držák T  
 T mounting plate

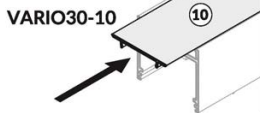
X

VARIO30-01  
VARIO30-02  
VARIO30-03  
difuzor / diffuser  
A9, C9, D9, E9

VARIO30-10



FIX16

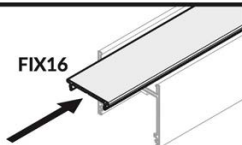

VARIO30-08

VARIO30-09

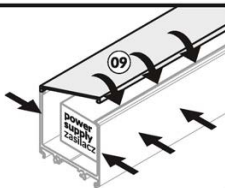
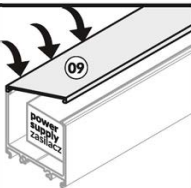

## XI SPOJKY / CONNECTORS

VARIO30-02  
VARIO30-03  
difuzor / diffuser  
A9, C9, D9, E9

Dostupné úhlové spojky:  
Available angular connectors:

Spojka VARIO30-02 60° / VARIO30-02 connector 60 deg  
Spojka VARIO30-02 90° / VARIO30-02 connector 90 deg  
Spojka VARIO30-02 90° vertikální / VARIO30-02 connector 90 deg bent  
Spojka VARIO30-02 135° vertikální / VARIO30-02 connector 135 deg  
Spojka VARIO30-0203 180° / VARIO30-0203 connector 180 deg  
Spojka VARIO30-02 270° vertikální / VARIO30-02 270 connector deg bent



60°



90°



90° vert / bent



120°



135°



180°



270° vert / bent

VARIO30-02  
VARIO30-03  
difuzor / diffuser  
A9, C9, D9, E9

spojka 180°  
connector 180 deg

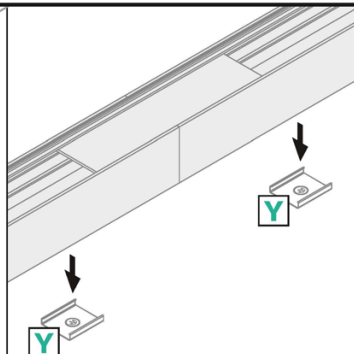
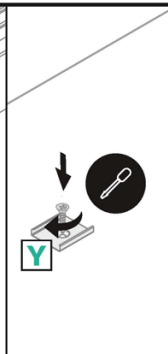
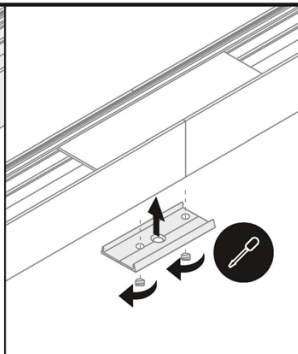
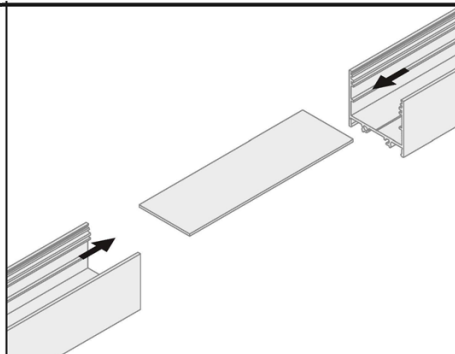

VARIO30-02  
difuzor / diffuser  
A9, C9, D9, E9

spojky:  
60°, 90°, 90° vert,  
135°, 270° vert  
connectors:  
60 deg, 90 deg,  
90 deg bent, 135 deg,  
270 deg bent

Všechny spojky se instalují podobně  
jako spojka VARIO30-02 90°  
Every connector is installed similarly to  
VARIO30-02 connector 90 deg

spojka VARIO30-02 90°  
VARIO30-02 connector 90 deg

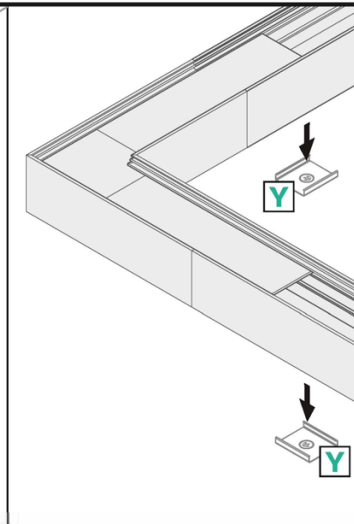
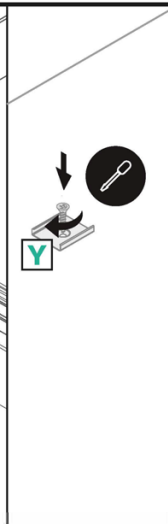
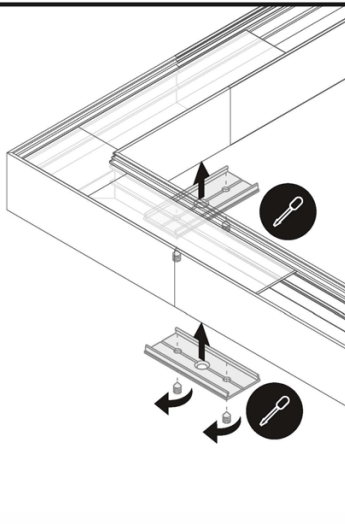
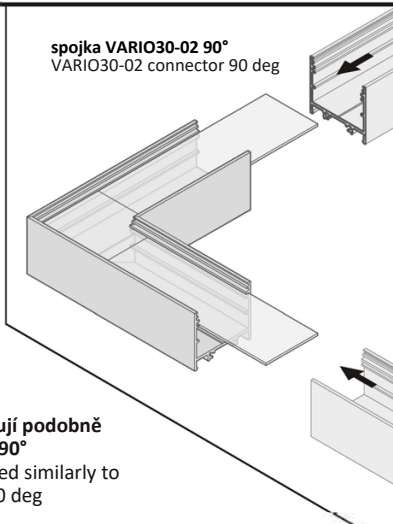

## XII NAPÁJECÍ ZDROJ / POWER SUPPLY

VARIO30-01  
VARIO30-02  
VARIO30-03  
difuzor / diffuser  
A9, C9, D9, E9

VARIO30-08

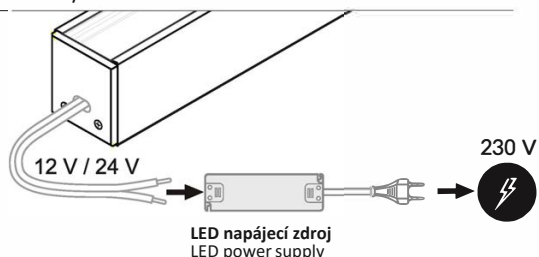

## PŘÍSLUŠENSTVÍ / ACCESSORIES

- spínače / power switches
- stmívače + ovladače / controller + remote
- pohybové senzory / movement sensors

Zjistěte více - [www.tron.cz](http://www.tron.cz)  
Find out more - [www.tron.cz](http://www.tron.cz)

**TRON**

TRON elektronické součástky s.r.o.  
[www.tron.cz](http://www.tron.cz)